

□40

TS4603 100W

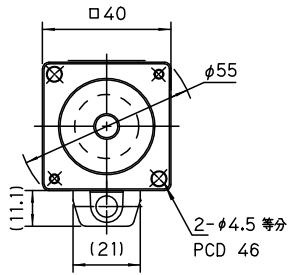

(二面フライス)

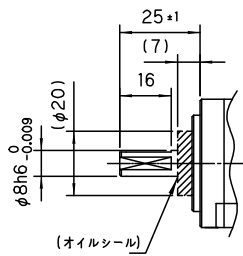
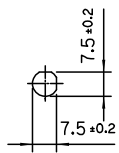

(キー溝)

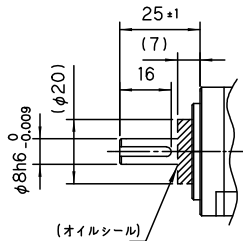
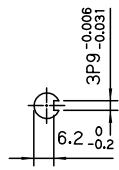

付属キー 3x3x16 (片丸)

(丸軸)

保持ブレーキ無し

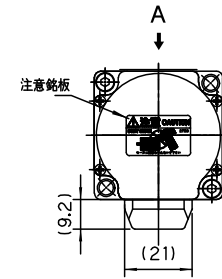
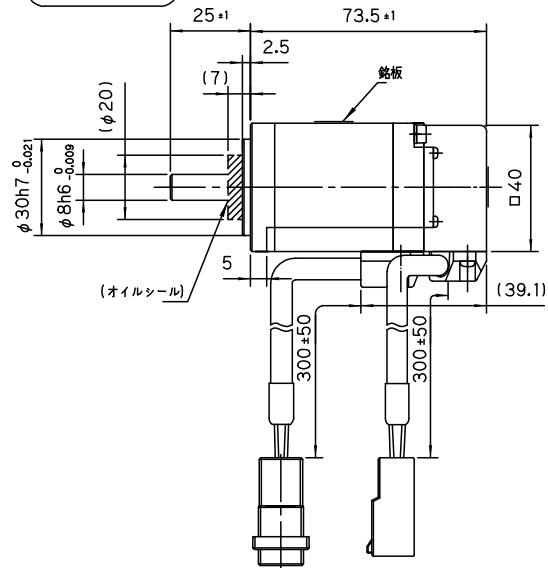

矢視 A

保持ブレーキ付き

