

□40

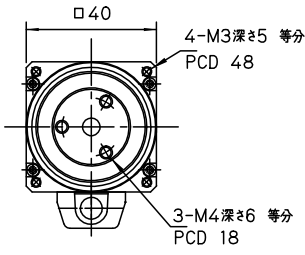

保持ブレーキ無し

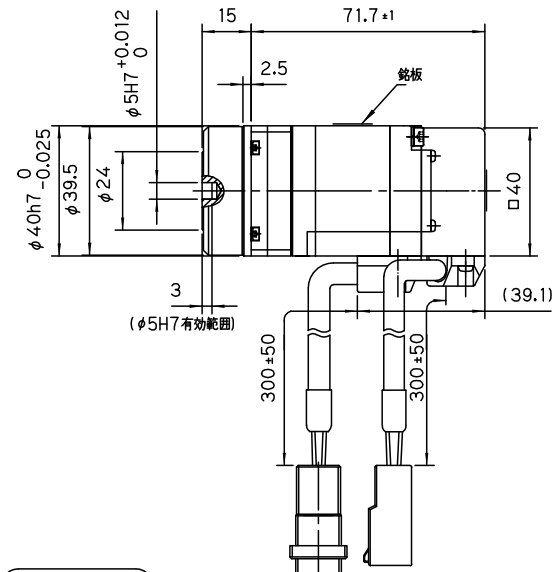

TS4602 . . . . . 50W  
減速比 . . . 1/5 or 1/9

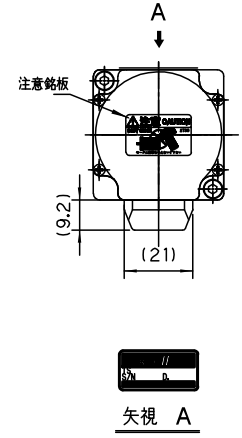

保持ブレーキ付き

